

WINDLIGHT *Led profiles*



FBS Profilati srl, fondata nel 1999 dalla seconda generazione imprenditoriale della nostra famiglia, è un'azienda dinamica che trae la sua essenza dal concept del "MADE IN ITALY" tramandato attraverso l'esperienza delle sue figure storiche che dal 1964 si dedicano con entusiasmo alla progettazione e produzione di profili decorativi in alluminio e serrandine. Nella nostra sede di Settimo Milanese, che si sviluppa su una superficie complessiva di 5000 m², creiamo prodotti sempre all'avanguardia e al passo con le più moderne tendenze del mondo del design per arredamento di interni a partire da materie prime di qualità eccellente.

FBS Profilati srl, founded in 1999 by the second managerial generation in our family is a dynamic company deriving its essence from the concept of "MADE IN ITALY" handed down through the experience of senior figures who have enthusiastically committed to designing and manufacturing aluminium decorative profiles and tambour doors since 1964.

In our headquarters in Settimo Milanese, covering a total area of 5000m², we create forefront and contemporary products up-to-date with modern furniture design trends using exclusively excellent raw materials.



WINDLIGHT

Dall'esperienza FBS Profilati nella profilatura a freddo nasce la prima barra per strisce LED estetica, sia a luce accesa che a luce spenta: quando la fonte luminosa è accesa, la luce si diffonde uniformemente attraverso lo schermo in alluminio micro-perforato creando una linea luminosa omogenea. Quando la luce è spenta lo schermo in finitura metallica diventa un prezioso dettaglio. Una famiglia di profili per LED unici e innovativi, declinati in vibranti finiture, che è in grado di soddisfare qualsiasi esigenza di interior design.

Thanks to FBS Profilati experience in roll forming the first decorative LED profile was created. When the light is on, the micro-perforated aluminum screen provides diffused lighting. When the light is off, the metallic screen becomes a precious detail. In a sea of silver and black bars, FBS aluminum colorways will turn heads everywhere.

An innovative and unique LED profile collection, available in exciting finishes, that will satisfy any interior design need.



materiali riciclabili
recyclable materials



qualità
quality



resistenza
endurance



installazione rapida
fast installation

PROFILI DA APPOGGIO
SURFACE MOUNTED

E1

E1WIND

PROFILI DA INCASSO
RECESSED MOUNTED

R1

M1

.....
SPECIFICHE TECNICHE
TECHNICAL SPECIFICATIONS

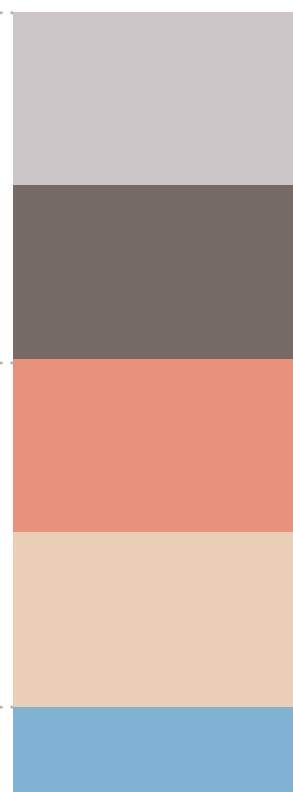



WINDLIGHT

E1

Profilo da appoggio Surface mounted application

LUNGHEZZA BARRE BAR LENGTH	3000 mm
INGOMBRO PROFILO PROFILE DIMENSIONS	16,5 x 13 mm
FISSAGGIO FIXING	biadesivo / vite adhesive / screw

LUMINOSO ED ECOSOSTENIBILE!

La prima barra per strisce led con schermo in alluminio estetico: quando la luce è spenta lo schermo in finitura metallica diventa un prezioso dettaglio. Composta da tre elementi separati che semplificano al massimo l'installazione su misura del prodotto.

BRIGHT AND SUSTAINABLE!

The first bar for LED strips with an aesthetic aluminum screen: when the light is turned off, the screen in metallic finish becomes a precious detail. Composed of three separate elements making the installation easy for everyone.



Diffusione luce *Light diffusion*

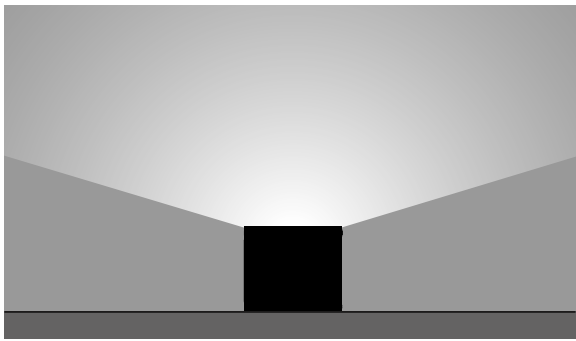

misure in mm - dimensions in mm

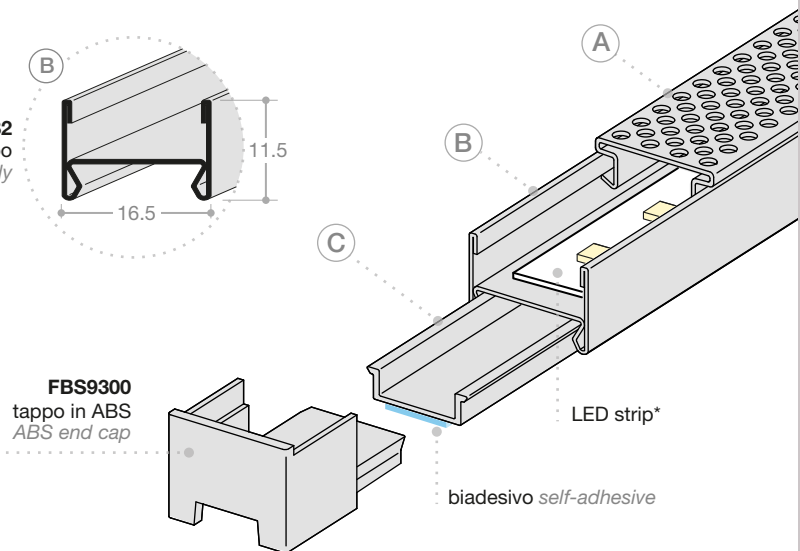
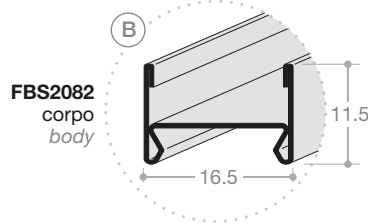
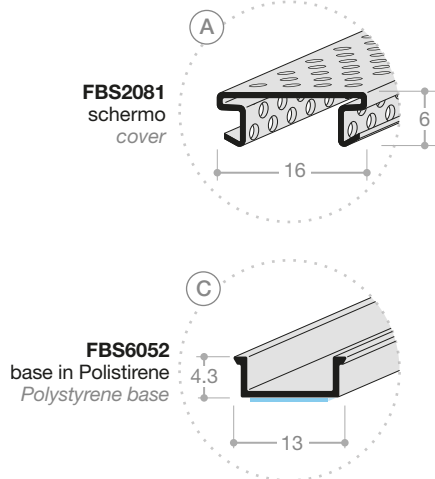

Varianti *Options*

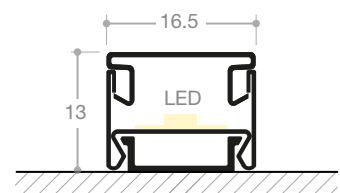
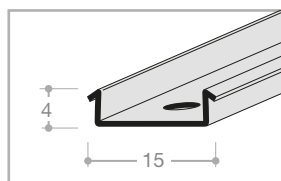
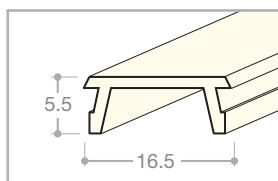

* Striscia LED non fornita
LED strip not supplied.

Finitura *Finishing*

ANODIZZATI ANODIZED

- B3 - mill gold
- RA - copper
- D2 - gold
- D - chrome
- SN - sat nat
- A2 - inox brushed

PREVERNICIATI PREPAINTED

- L2 - matt black
- U9 - anthracite
- M4 - matt white



WINDLIGHT **E1**WIND

Profilo da appoggio Surface mounted application

LUNGHEZZA BARRE BAR LENGTH	3000 mm
INGOMBRO PROFILO PROFILE DIMENSIONS	16,5 x 13 mm
FISSAGGIO FIXING	biadesivo / vite adhesive / screw

LUCE IN 3D

In questa versione la micro foratura è estesa su tre lati. Come optional lo schermo in alluminio pieno permette di creare una diffusione della luce d'atmosfera e, quando spento, una decorazione preziosa.

3D LIGHT

In the WIND model the micro perforation is spread on all three sides. The optional full aluminium screen creates lateral mood light and, when turned off, becomes a precious decoration.

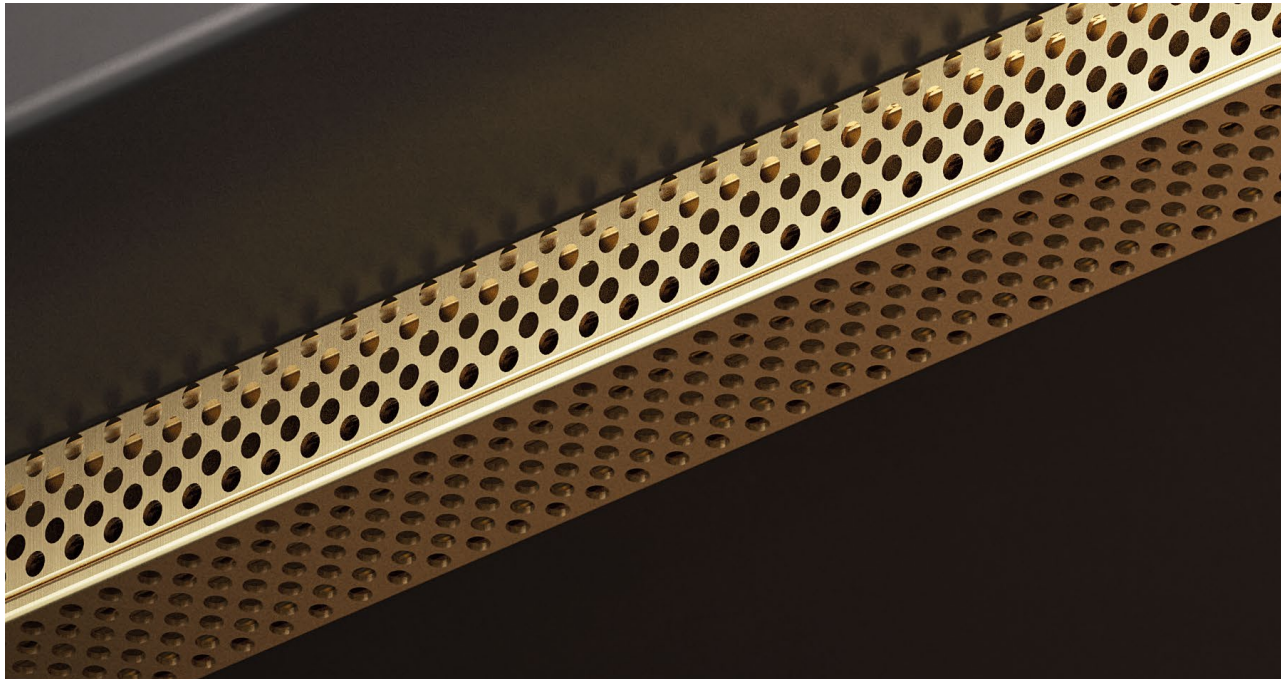

Diffusione luce *Light diffusion*

FBS2081 wind / FBS6050

FBS2081 cieco blind

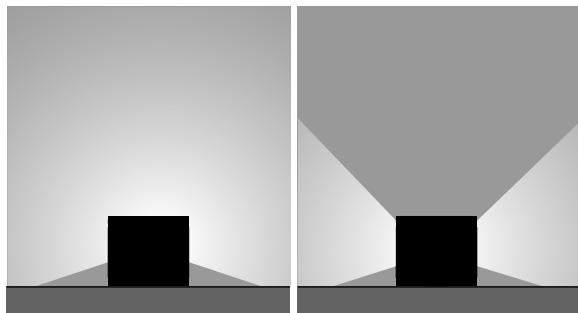

misure in mm - dimensions in mm

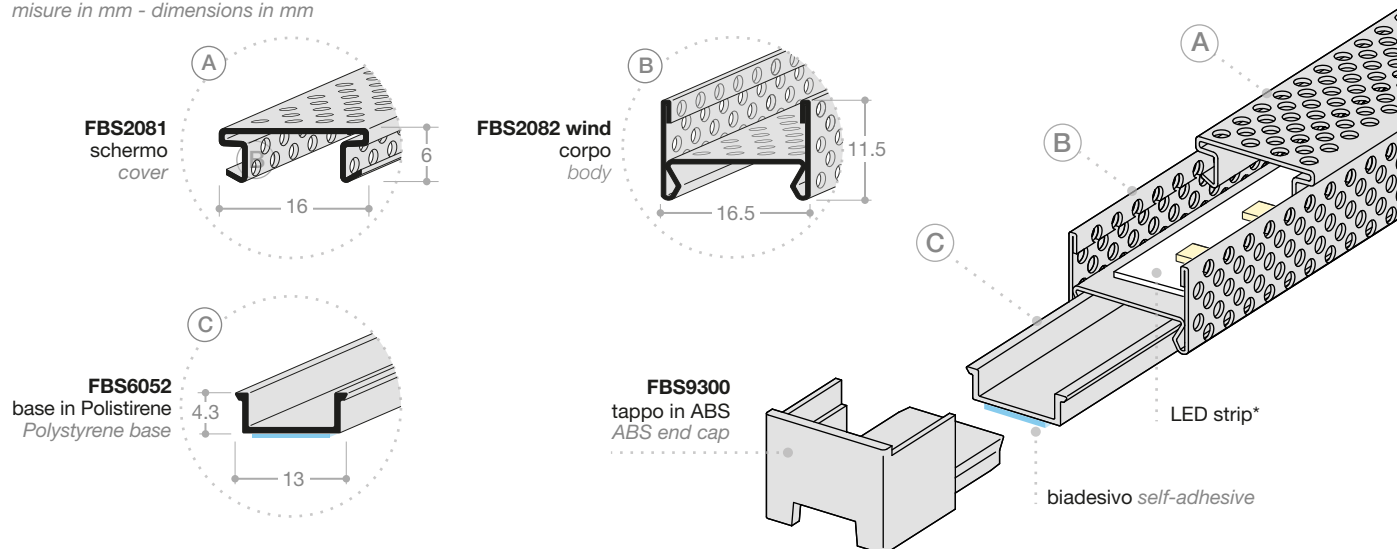



Finitura *Finishing*

ANODIZZATI ANODIZED

PREVERNICIATI PREPAINTED

-  B3 - mill gold
-  RA - copper
-  D2 - gold
-  D - chrome
-  SN - sat nat
-  A2 - inox brushed

-  L2 - matt black
-  U9 - anthracite
-  M4 - matt white

Varianti *Options*

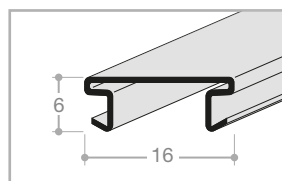

FBS2081 pieno
schermo cieco blind cover

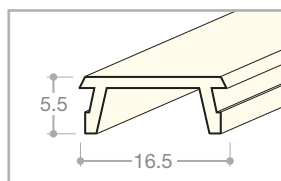

FBS6050
schermo opalino opaline cover

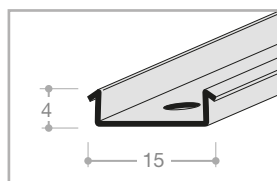

FBS2080
Profilo base in alluminio SN
Aluminium fixing profile SN

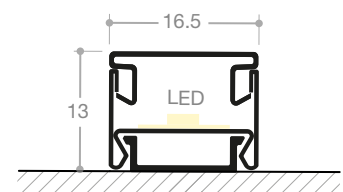

* Striscia LED non fornita
LED strip not supplied.



WINDLIGHT

R1

Profilo da incasso Recessed mounted application

LUNGHEZZA BARRE BAR LENGTH	3000 mm
INGOMBRO PROFILO PROFILE DIMENSIONS	16,8 x 9 mm
FISSAGGIO FIXING	colla glue

UN CLASSICO MODERNO

L' innovativo profilo in alluminio per strisce led realizzato con la nostra tecnologia di profilatura a freddo. Grazie allo spessore ridotto ed al pratico profilo copri fresata di facile utilizzo per tutti.

A MODERN CLASSIC

The innovative aluminum profile for led strips made with our roll forming technology. Thanks to the reduced depth and the specific milling cover, it is easy to use for everyone.

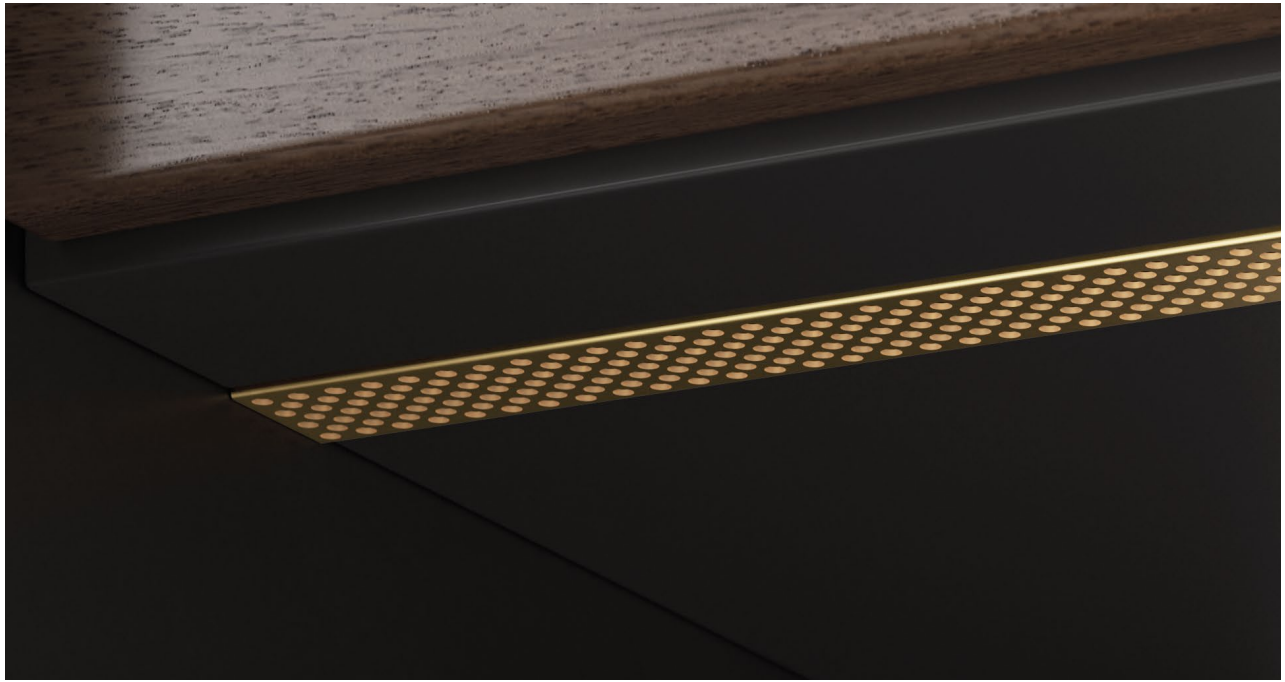

Diffusione luce *Light diffusion*

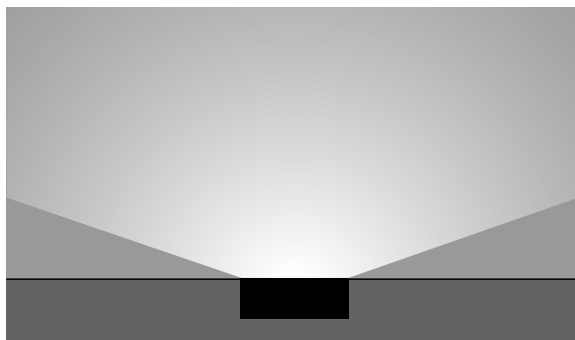

misure in mm - dimensions in mm

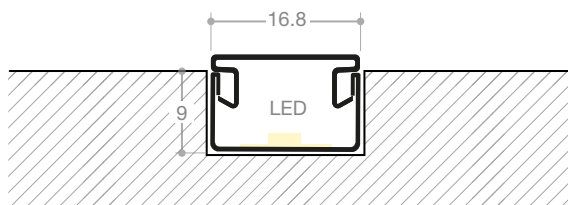
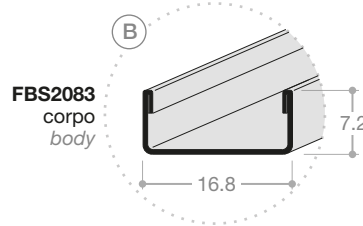
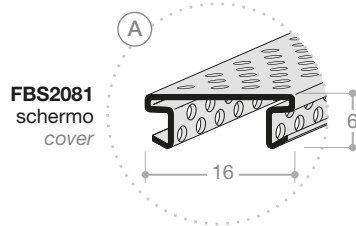

Varianti *Options*

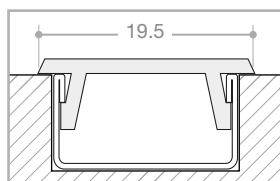

FBS6051
schermo opalino coprifresata
opaline milling cover

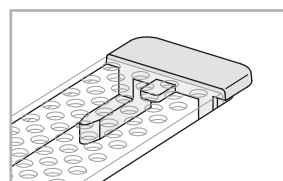



FBS9301
tappo in Nylon per FBS6051
Nylon end cap for FBS6051

Finitura *Finishing*

ANODIZZATI ANODIZED

-  **B3** - mill gold
-  **RA** - copper
-  **D2** - gold
-  **D** - chrome
-  **SN** - sat nat
-  **A2** - inox brushed

PREVERNICIATI PREPAINTED

-  **L2** - matt black
-  **U9** - anthracite
-  **M4** - matt white

NOTA: FBS2083 SOLO
IN FINITURA **SN**
NOTE: FBS2083 ONLY
AVAILABLE IN **SN** FINISHING

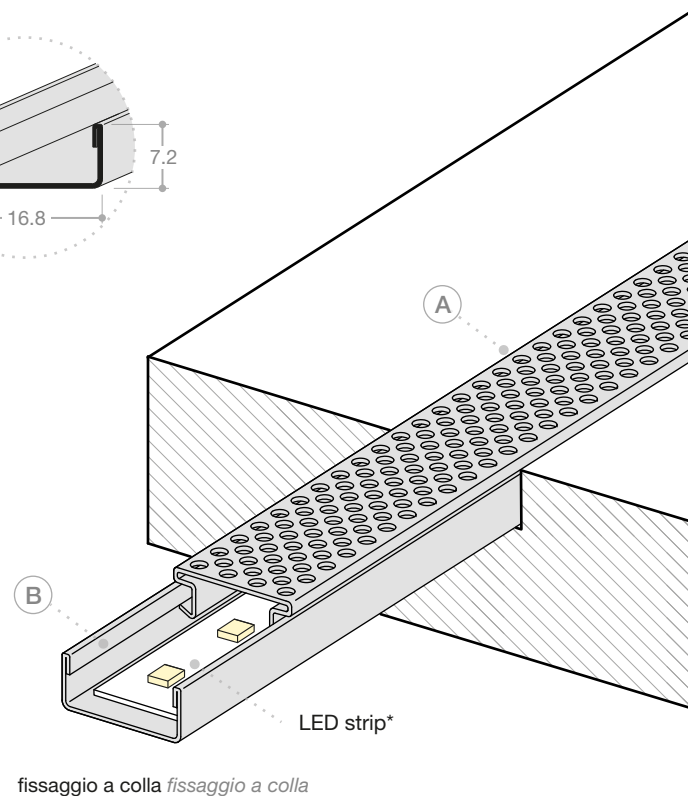

* Striscia LED non fornita
LED strip not supplied.



WINDLIGHT **M1**

Profilo da incasso Recessed mounted application

LUNGHEZZA BARRE BAR LENGTH	3000 mm
INGOMBRO PROFILO PROFILE DIMENSIONS	7,4 x 8,5 mm
FISSAGGIO FIXING	colla glue

LO STRETTO NECESSARIO

Stesso design e fascino, in una forma più raffinata e minimalista. M1 diventa più piccolo ed elegante, pur mantenendo le stesse prestazioni dei profili più grandi.

THE BARE MINIMUM

Same design and allure, in a more refined and minimalist form.

M1 gets smaller and sleeker, though it retains the very same performance as the bigger profiles.



Diffusione luce *Light diffusion*

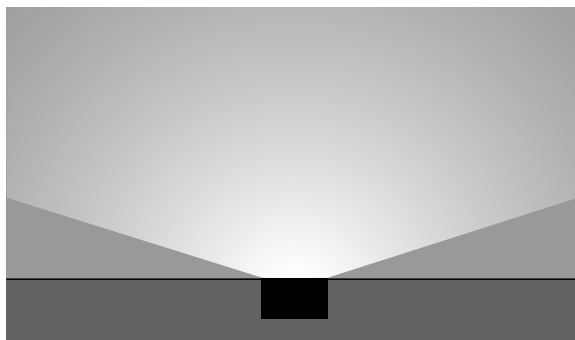

misure in mm - dimensions in mm

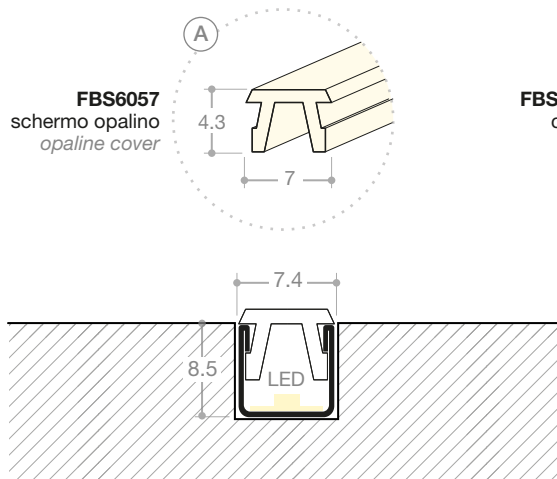

Varianti *Options*

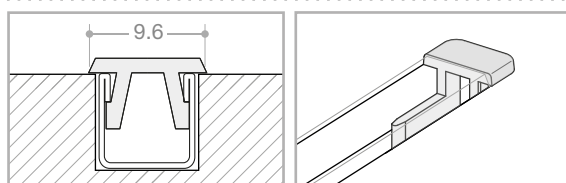

FBS6056
schermo coprifresata
milling cover

FBS9303
tappo in Nylon per FBS6051
Nylon end cap for FBS6051

Finitura *Finishing*

NOTA: FBS2084 SOLO IN FINITURA **SN**
NOTE: FBS2084 ONLY AVAILABLE IN **SN** FINISHING



SN - sat nat

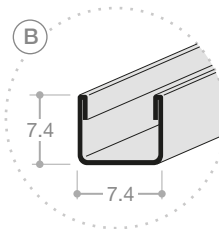

FBS2084
corpo
body

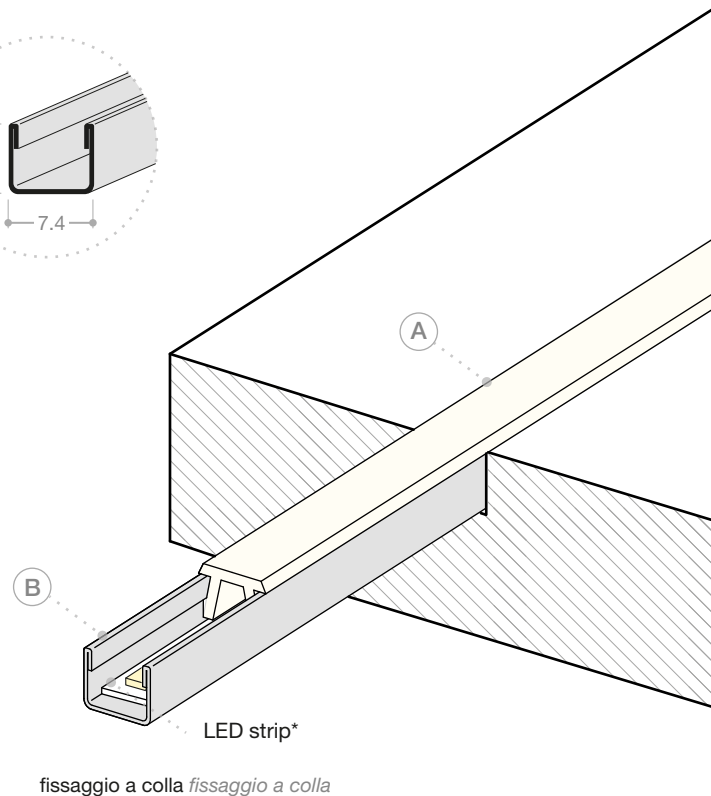

* Striscia LED non fornita
LED strip not supplied.

Montaggio E1 - E1WIND *Assembly E1 - E1WIND*

IMPORTANTE! Per un fissaggio ottimale del biadesivo, assicurarsi che le superfici siano pulite con un detergente e completamente asciutte.

IMPORTANT! For best results with the self-adhesive, please make sure the surfaces are cleaned with a detergent and perfectly dry.

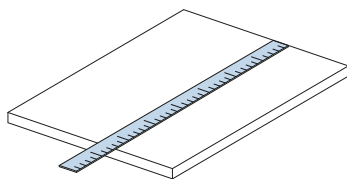

1. Misurare la lunghezza necessaria e tagliare a misura i profili seguendo le indicazioni sottoriportate. *Take the measure of the required length and cut the profiles to size following the instructions below*

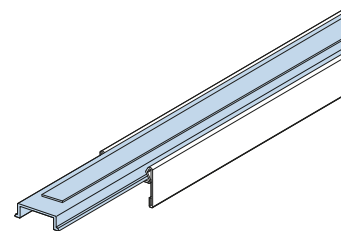

2. Inserire il profilo "BASE" nel profilo "CORPO". *Insert the "BASE" profile into "BODY" profile.*

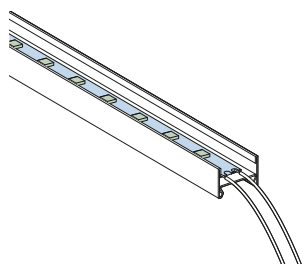

3. Tagliare a misura ed incollare la striscia LED sul profilo. *Cut the LED strip to size and glue it onto the profile*

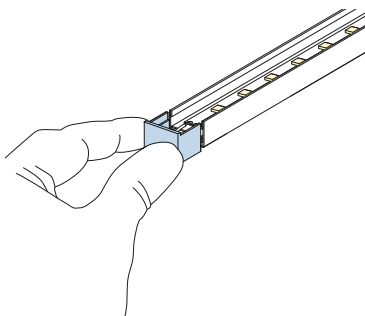

4. Inserire i tappi. *Insert the end-caps*

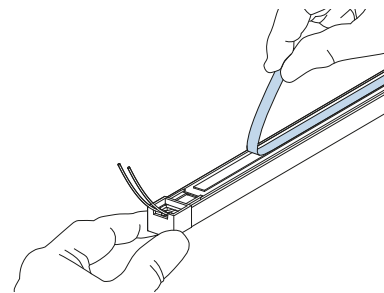

5. Rimuovere il film del biadesivo. *Remove film from the self-adhesive strip.*

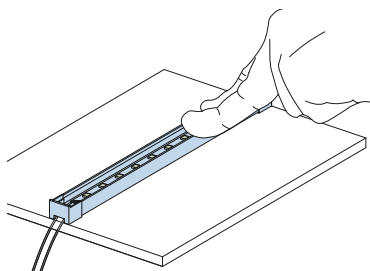

6. Incollare con una leggera pressione il profilo alla superficie. *Stick the profile onto the surface applying a light pressure.*

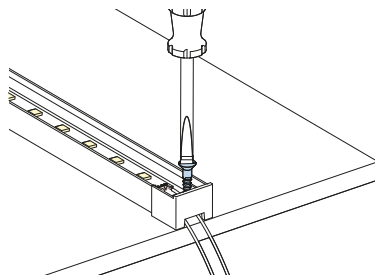

7. Se necessario fissare i tappi con delle viti. *If necessary, fix the profile's end caps with screws*

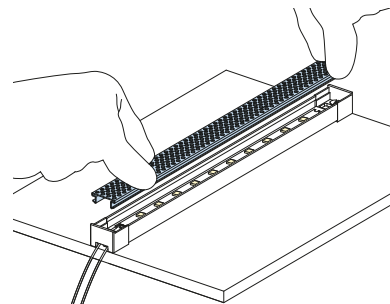

8. Fissare lo schermo a pressione. *Clip the cover on.*

TAGLIO BARRE - MISURE PER VERSIONE CON TAPPI BARS CUTTING - DIMENSIONS FOR THE VERSION WITH END-CAPS

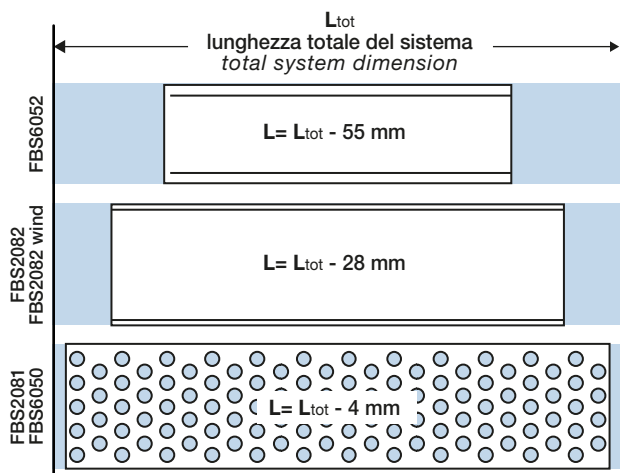

FISSAGGIO A VITE - SOLO PER E1 E E1WIND SCREW FIXING - ONLY FOR E1 AND E1WIND

In alternativa all'adesivo, è possibile fissare la barra led tramite viti, utilizzando il profilo FBS2080 in sostituzione al profilo FBS6052. *As an alternative to using self-adhesive, there is the option of fixing with screws by using profile FBS2080 instead of profile FBS6052.*

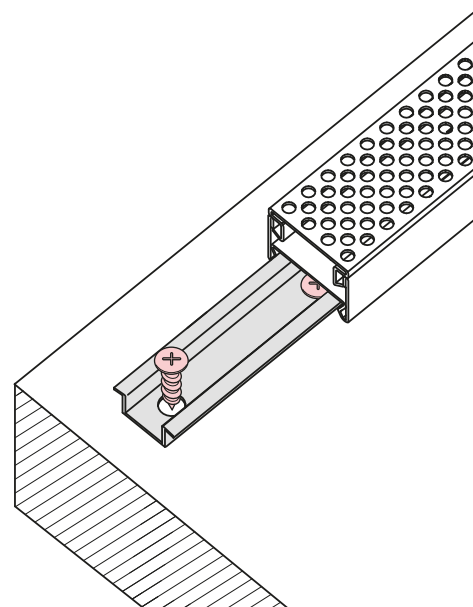
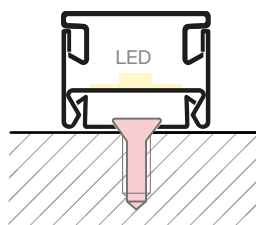

Per installazione con tappi FBS 9300, i tre profili devono essere tagliati considerando le misure indicate. *For installations with FBS9300 end-caps, the three profiles composing the system must be cut considering the dimensions diagram.*

Montaggio R1 - M1 *Assembly R1 - M1*

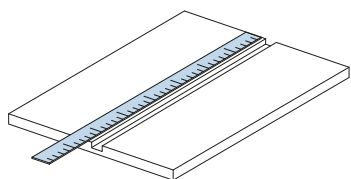

1. Misurare la lunghezza necessaria.
Take the measure of the required length.

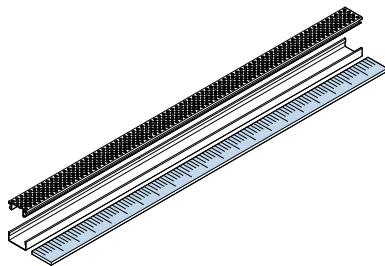

2. Tagliare a misura i profili. *Cut the profiles to size.*

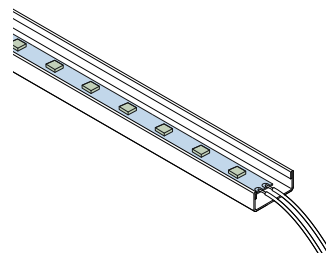

3. Tagliare a misura ed incollare la striscia LED sul profilo. *Cut the LED strip to size and glue it onto the profile.*

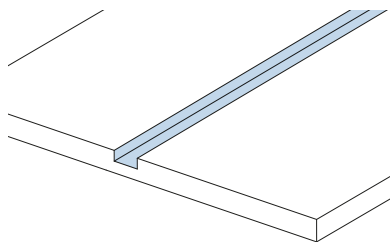

In caso di fresata continua, passare al punto 5. *In case of continuous milling, go to instruction n. 6.*

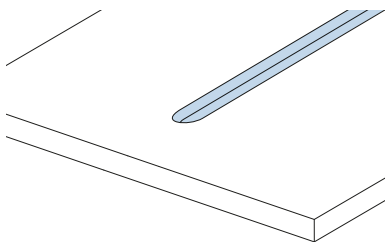

In caso di fresata interrotta, sono necessari gli appositi tappi coprifresata. *In case of interrupted milling, the specific milling-cover endcaps are necessary.*

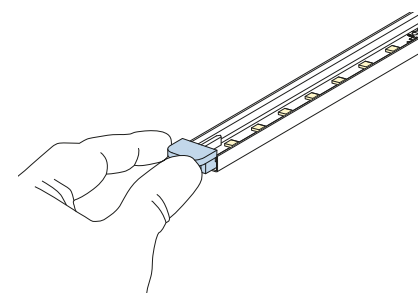

4. Inserire i tappi coprifresata. *Insert the milling-cover endcaps.*

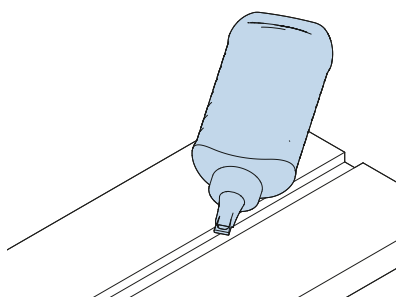

5. Versare la colla nella fresata.
Pour some glue into the milling channel

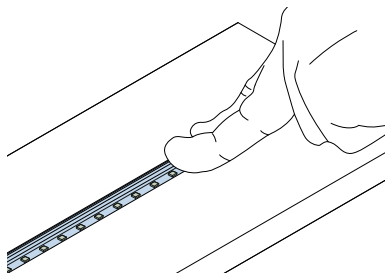

6. Incollare con una leggera pressione il profilo alla superficie. *Stick the profile onto the surface applying a light pressure.*

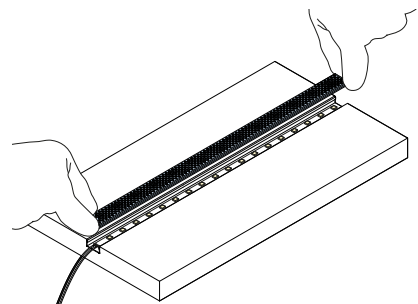

7. Fissare lo schermo a pressione. *Clip the cover on.*

Specifiche *Technical details*

ALLUMINIO PROFILATO A FREDDO

Windlight risponde a due importanti trend dell'interior design: materiali sostenibili e personalizzazione.

L'alluminio utilizzato in 9 finiture senza tempo, è profilato a freddo e quindi facilmente lavorabile con normali attrezzi da falegnameria. I profili vengono forniti in barre standard di 3000 mm o tagliati su misura. Pellicola protettiva inclusa

VERSATILE AND MACHINING-FRIENDLY

Windlight is a technical and aesthetic answer to two interior design trends: sustainable materials and personalisation.

The roll formed aluminium profiles, in 9 timeless finishes, can be machined with standard carpenters tools.

The profiles are supplied either in 3000 mm long bars or cut to size as per client specifications. Protective film included.

MICROFORATURA PER UN'ILLUMINAZIONE DI DESIGN

Questa originale lavorazione di micro-foratura dell'alluminio favorisce la dispersione del calore generato dal LED e arricchisce la texture della superficie con contrasti pieno/vuoto.

PERFORATION FOR UNIQUE LIGHTING DESIGN

The innovative perforation process on the aluminium helps to dissipate the heat generated by the LED and it greatly enhance the texture for a stunning aesthetic result.

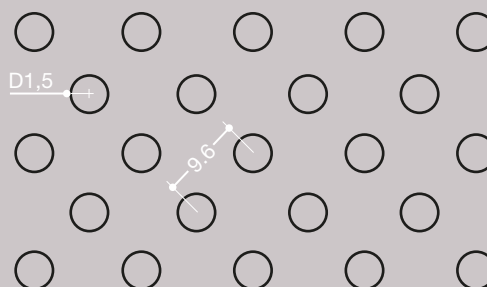

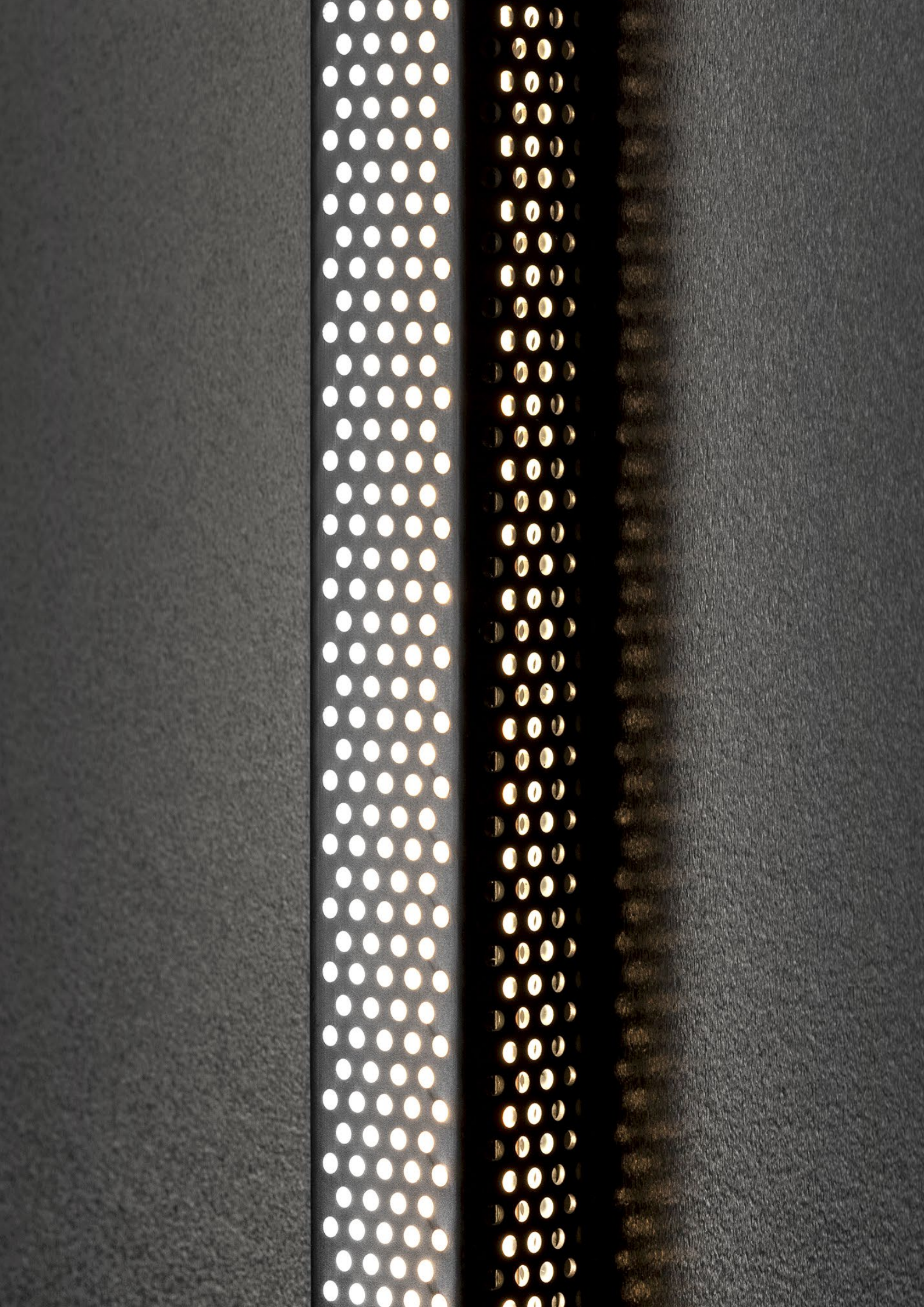

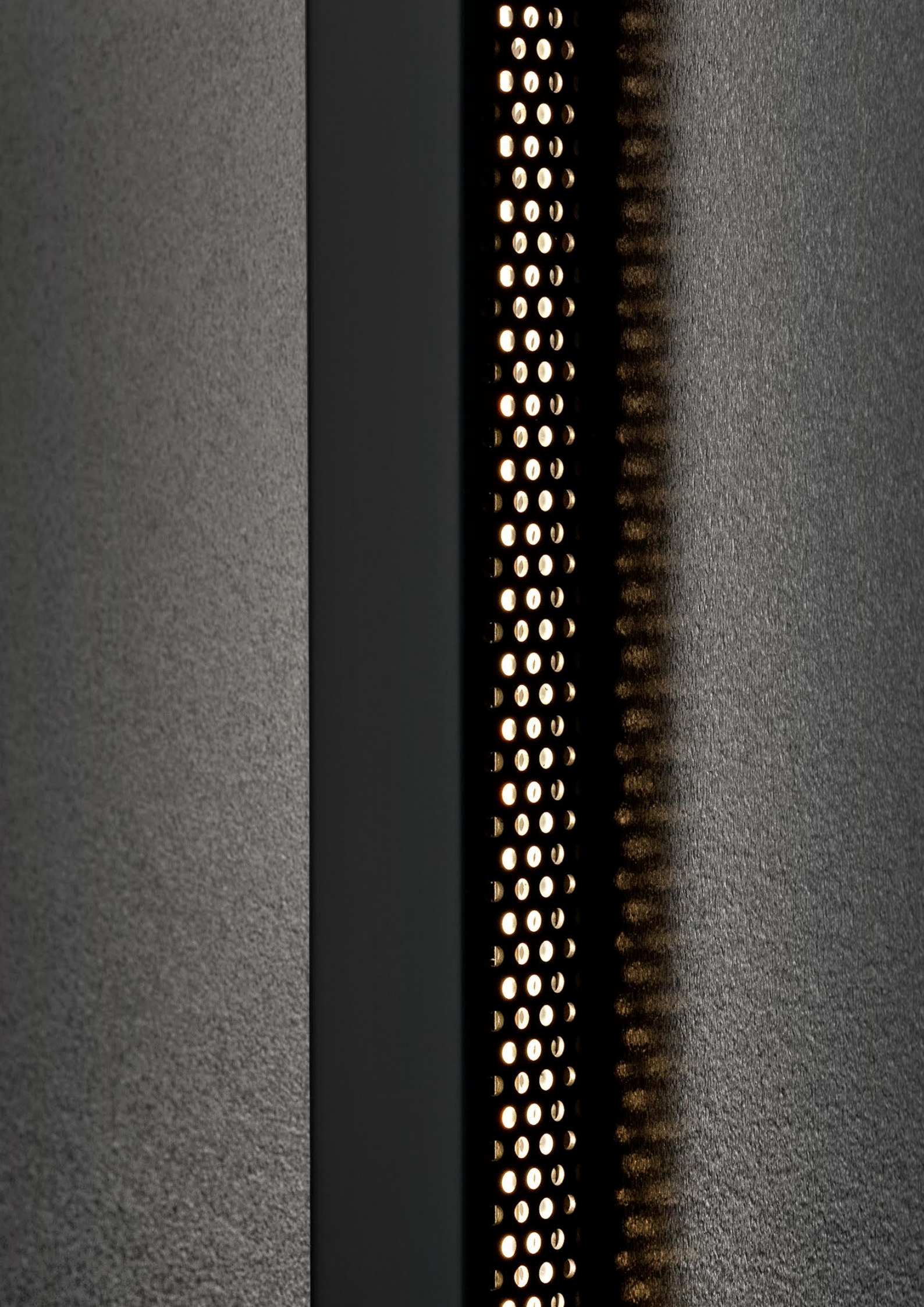

Il presente catalogo è di proprietà di FBSProfilati S.r.l.
Tutti i diritti riservati.
Sono vietate la riproduzione e alterazione.

Illustrazioni e dati contenuti in questo catalogo hanno
valore indicativo. Per una corretta installazione fare
riferimento ai manuali.

This catalogue is property of FBSProfilati S.r.l.
All rights reserved.
The reproduction and alteration are forbidden.

All illustrations and informations in this catalogue
are indicative. For a correct installation please refer
to the assembly instructions manuals.



PROFILATI ITALIANI

FBSProfilati srl

Via Edison, 251
20019 Settimo Milanese MI - Italia

phone: +39 024564768 | +39 0248916411
fax: +39 0245329991

info@fbsprofilati.it

www.fbsprofilati.it